

Cielo Smart Thermostat

Installation Guide



Thanks for choosing Cielo for your
home climate control!

Cielo Smart Thermostat is designed and optimized
to save energy while prioritizing comfort.

Simple to Install | Easy to Use | Saves You Energy

Let's Start!



Tools you need:

Drill for mounting anchors (3/16" drill bit)

Small flathead screwdriver

Phillips screwdriver

Wire stripper (optional)

Hammer (optional)

Pencil (optional)

Included in the box:



Cielo Smart Thermostat

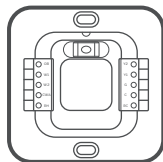

Thermostat Backplate



C-Wire Adapter

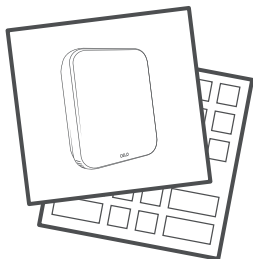

Installation Guide
and Wire Labels

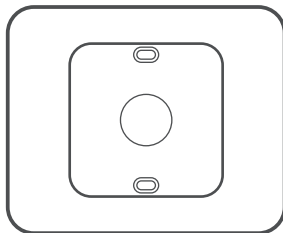

Thermostat Wall Plate

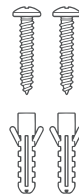

Mounting Screws With
Drywall Anchors

Getting Help

No long queues, no bots, no delays.
We answer 98% calls in less than 2 minutes and
guarantee that you will **talk to a REAL person.**

Visit our website:
[cielowigle.com](https://www.cielowigle.com)
and **select support to**
access user guides.



Email us at: support@cielowigle.com

Call us at : **+1 (425) 529-5775**

9:00AM - 9:00PM EST, Mon-Fri



Let's Install Your Thermostat

Step 1:

Safety First - Power off your HVAC system using:

- 1 The master switch
- OR
- 2 The circuit breaker

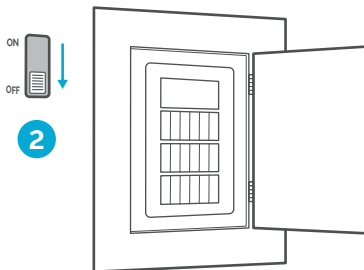
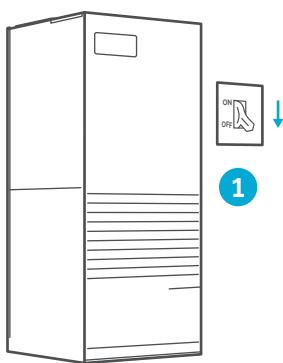

Step 2:

To be on the safe side, **ensure that your system is completely switched off**. Double-check that:

- 1 No air is coming out of air vents

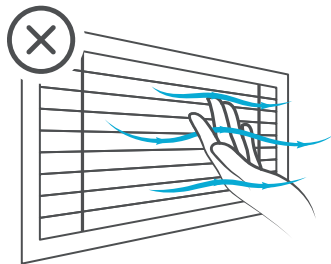
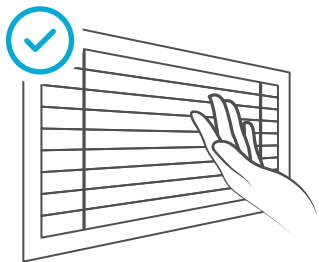

- 2 Main flame is extinguished in case of boiler

Step 3:

Go to your already installed thermostat and **remove it** from the wall.

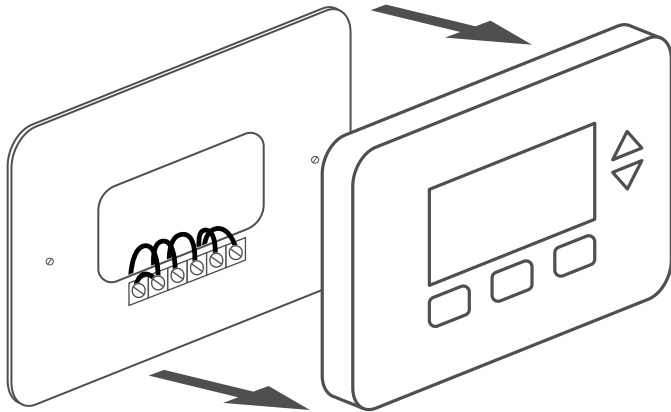

Step 4:

Look closely for any of the following indicators on your old thermostat's backplate:

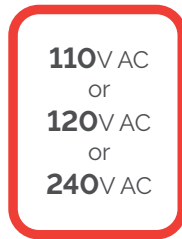
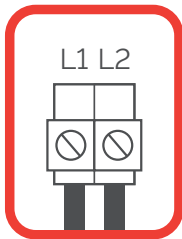

If you find any of the above indicators, **you should stop right here**, as your HVAC system might not be compatible.

In case of no such indicators, go to the next page.

WARNING:

Cielo Smart Thermostat only works with 24V AC.
It does not work with line (high) voltage or millivolt systems.

Step 5:

Grab your smartphone and **take a picture** of your old thermostat wiring.

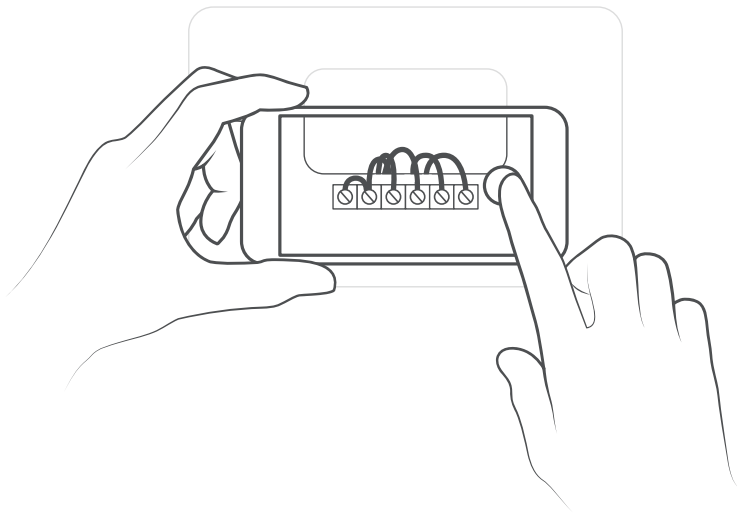

Step 6:

Does your old thermostat have a
C-Wire connection?

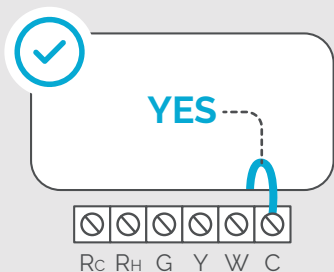

Continue to **Section 1**
on the Next Page

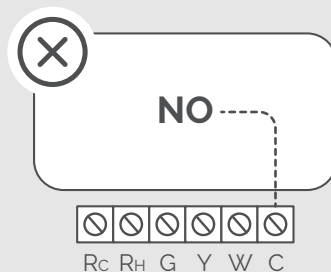

Continue to **Section 2**
on Page 24

Section 1

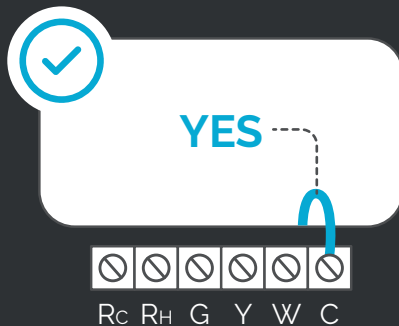

**Installing your
Cielo Smart Thermostat
with a C-Wire**

Step 7:

- 1 **Disconnect the old thermostat wires** one by one and mark them using the wire labels (included in the box).

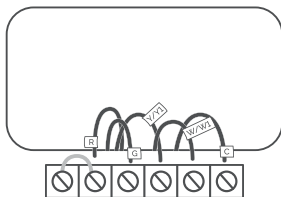

- 2 Remove the mounting plate of your old thermostat.

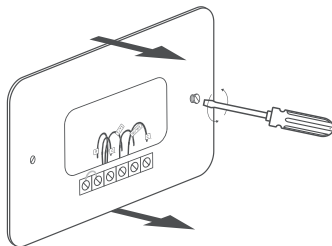

Step 8:

Optional: You may use the provided wall plate to hide marks or holes on the wall left by your old thermostat installation.

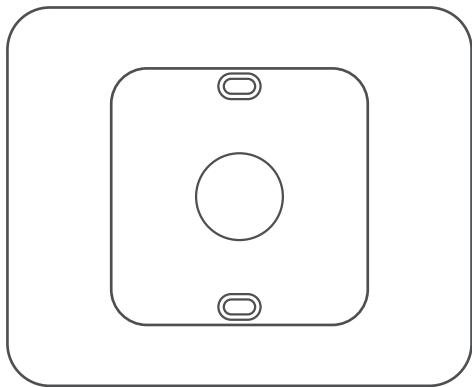

Step 9:

- 1 Take out the labeled wires through the hole in the middle of the Cielo Smart Thermostat backplate.
- 2 Screw in the backplate using the provided pair of drywall anchors and screws.

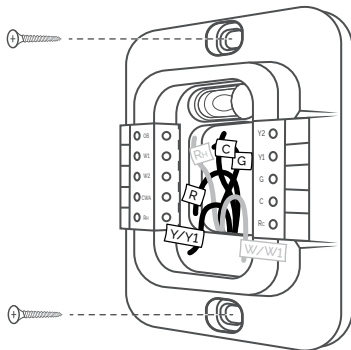

Step 10:

Do you have more than one R-Wire?
(That includes R, R_c, and R_H)

✓ YES

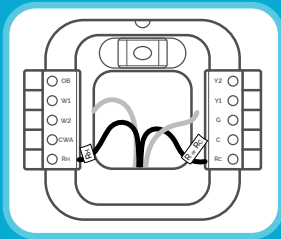

Insert your wires:
R_H → R_H R or R_c → R_c

⊗ NO

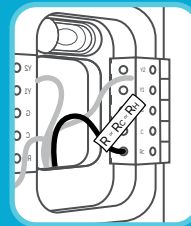

Insert your single
R, R_c, or R_H wire into
the **R_c** terminal.

Step 11:

Insert the remaining wires into their corresponding terminals from the side (press terminal block buttons for ease of insertion).

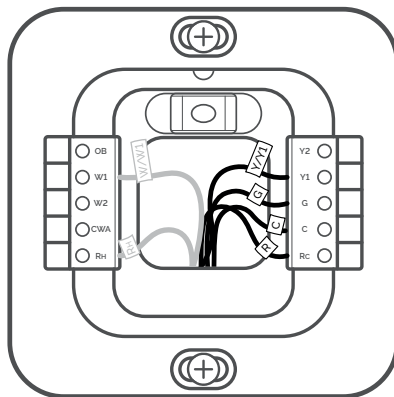

Step 12:

Gently push the excess wires back into the center hole of the backplate to ensure that no drafts are coming from the hole.

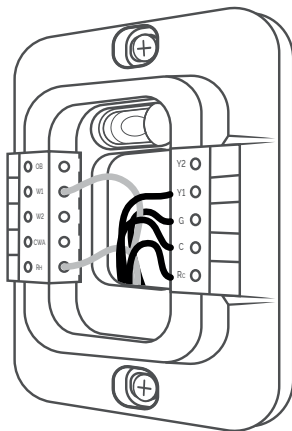

Step 13:

Align your **Cielo Smart Thermostat** with the backplate and press gently to **fix it properly**.

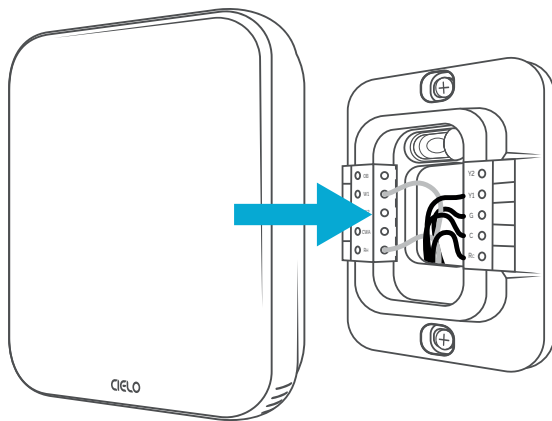

Step 14:

Go to your HVAC system and turn on the power from the master switch or circuit breaker.

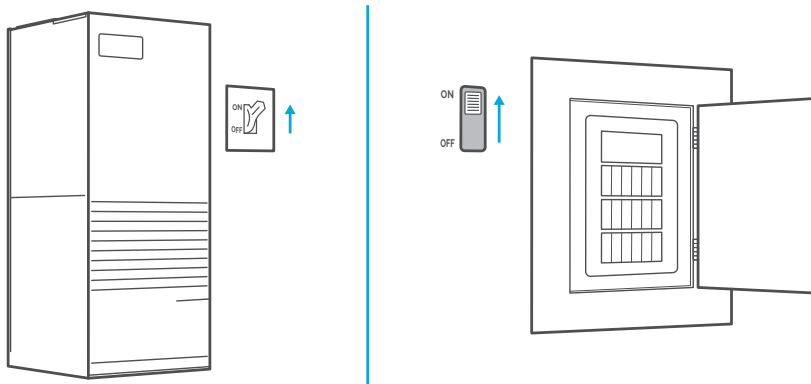

Step 15:

Welcome screen is displayed on Cielo Smart Thermostat!
Follow the on-screen instructions to register your thermostat.



Need Help?

Call: +1 (425) 529-5775 **Email:** support@cielowigle.com

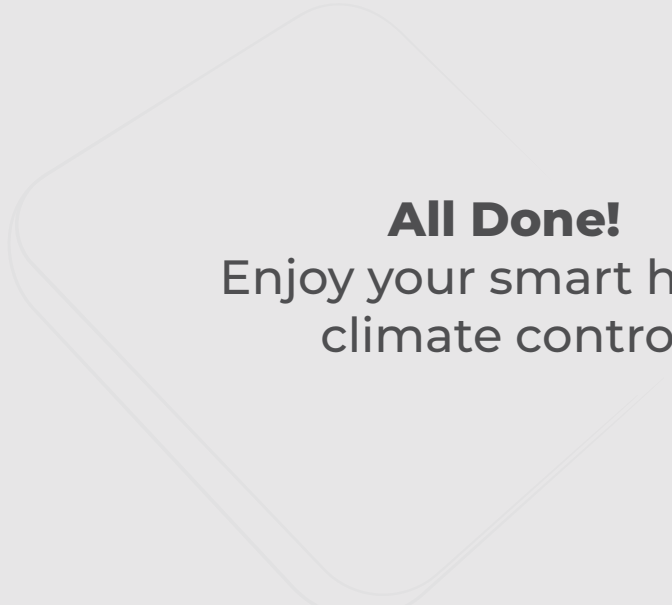

All Done!
Enjoy your smart home
climate control

Section 2

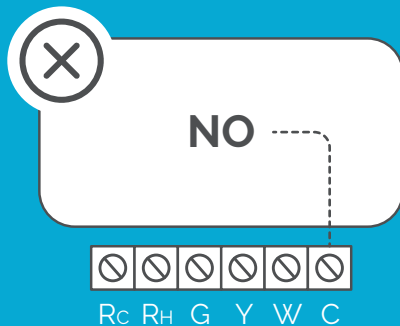

**Installing your
Cielo Smart Thermostat
without a C-Wire**

Step 7:

Take out **the C-Wire Adapter (CWA)** from the Cielo Smart Thermostat box.

(Ensure that you have already completed steps 1-5 of this guide)

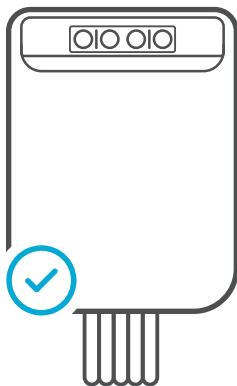

Step 8:

Your **system should have the following wires**
to work with the C-Wire Adapter:

4/5 Wires

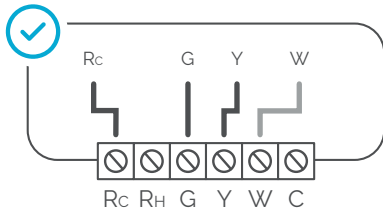
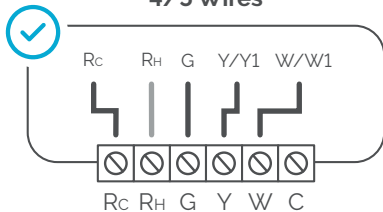

3/4 Wires

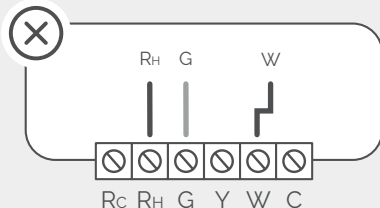
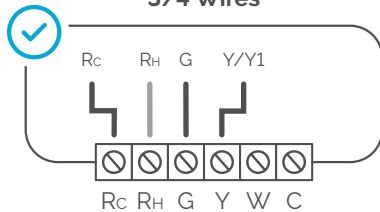

Contact Cielo support for more information.

Call: +1 (425) 529-5775

Email: support@cielowigle.com

Step 9:

Grab the C-Wire Adapter, wire labels, tools, your smartphone, and **go to your HVAC system.**

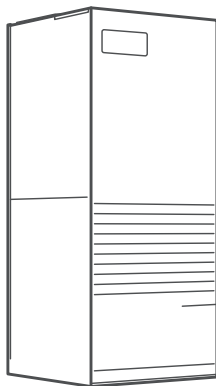

Step 10:

Take off your HVAC system's cover to **access the control board and take a picture of the connected wires**. You may need it at a later stage.

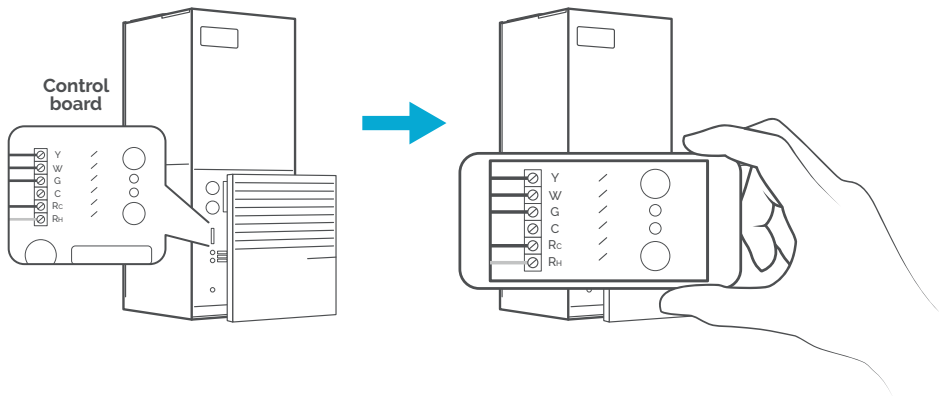

WARNING: Proceed with caution, as HVAC systems contain high-voltage wires.

Step 11:

Label only the following wires with the matching labels:

R - **Y or Y1** - **G** - **W or W1**

You only need to label the wires coming from your thermostat.

Ignore any extra wires going into the terminals.

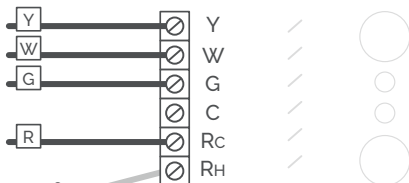

Note:

In the case of a two-transformer system (wires connected to both Rc and Rh terminals at the control board), please contact Cielo support to help you with installation. **Call:** +1 (425) 529-5775 **Email:** support@cielowigle.com

Step 12:

Disconnect the labeled **R**, **Y**, **G**, and **W** wires from the control board.

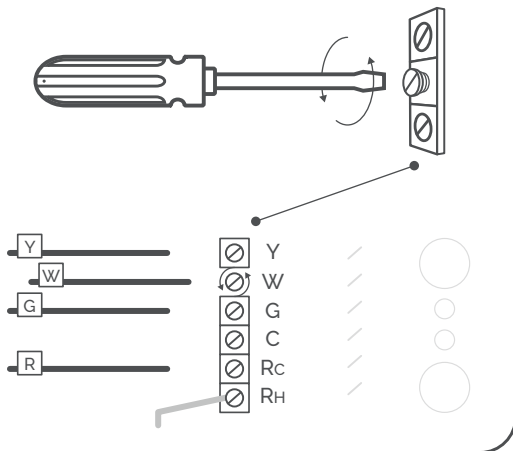

Step 13:

Securely connect the wires from the control board **to their matching terminals** on the CWA.

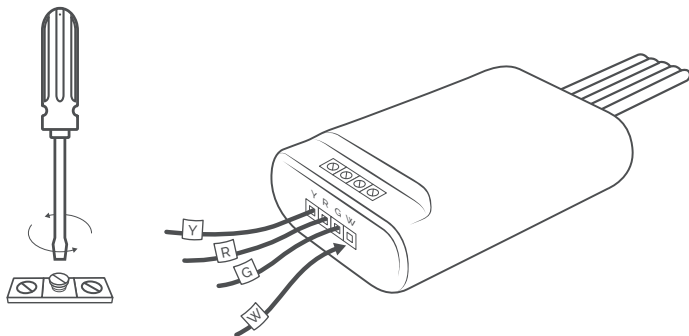

Step 14:

Securely connect all the wires coming out of the C-Wire Adapter to the corresponding terminals on the control board of your HVAC system.

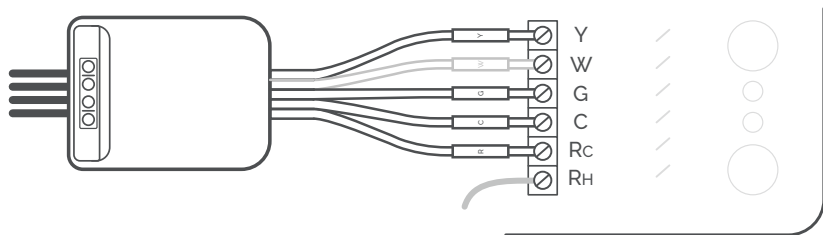

Step 15:

Place/mount the CWA at a suitable location inside your HVAC system. Close the HVAC cover panel securely and return to your old thermostat.

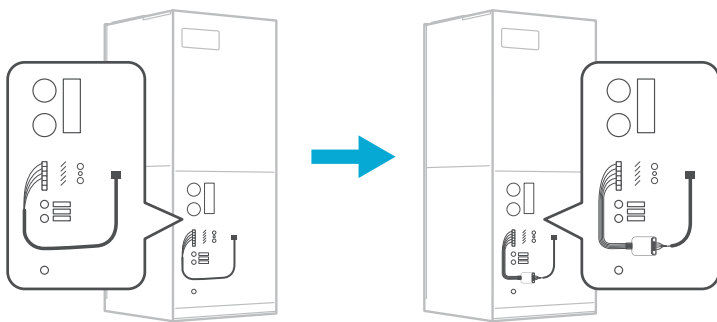

Step 16:

- 1 **Disconnect the old thermostat wires** one by one and mark them using the wire labels (included in the box).

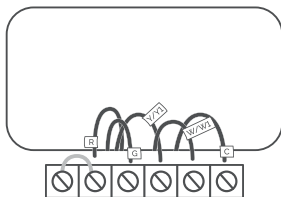

- 2 Remove the mounting plate of your old thermostat.

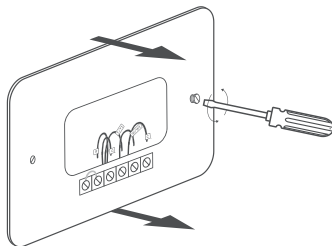

Step 17:

Optional: You may use the provided wall plate to hide marks or holes on the wall left by your old thermostat installation.

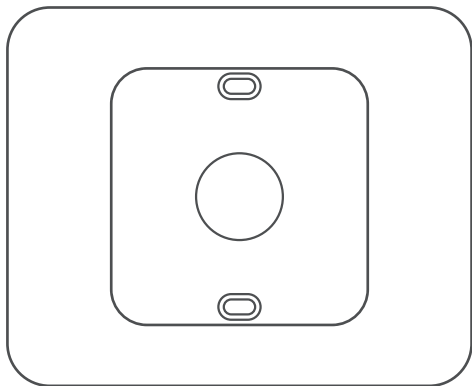

Step 18:

- 1 Take out the labeled wires through the hole in the middle of the Cielo Smart Thermostat backplate.
- 2 Screw in the backplate using the provided pair of drywall anchors and screws.

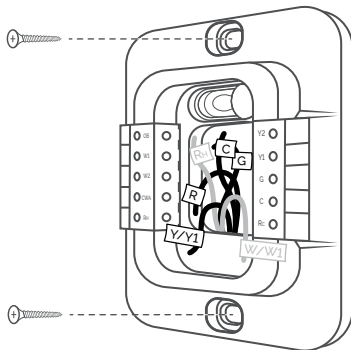

Step 19:

First, connect these 3 wires as shown:

R/Rc → **Rc**

G → **C**

Y/Y1 → **CWA**

Then, connect the remaining wires to their corresponding terminals (press terminal block buttons for ease of insertion).

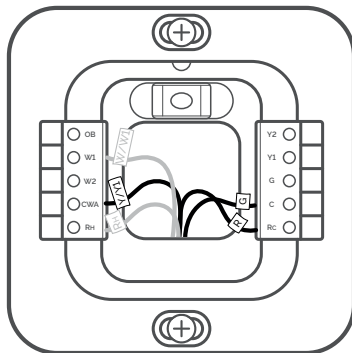

Step 20:

Gently push the excess wires back into the center hole of the backplate to ensure that no drafts are coming from the hole.

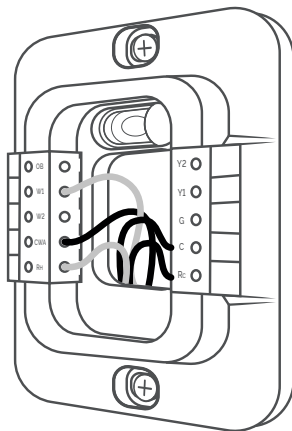

Step 21:

Align your **Cielo Smart Thermostat** with the backplate and press gently to **fix it properly**.

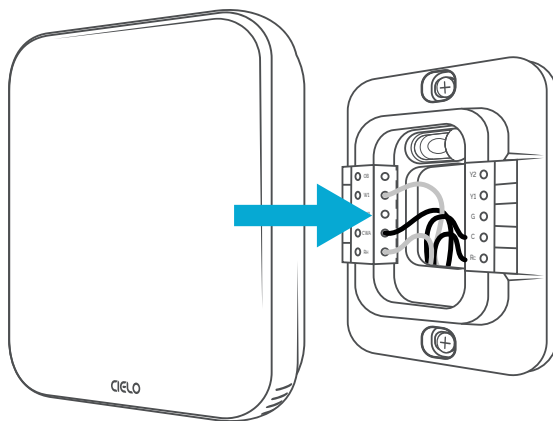

Step 22:

Go to your HVAC system and turn on the power from the master switch or circuit breaker.

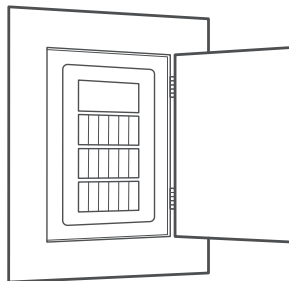
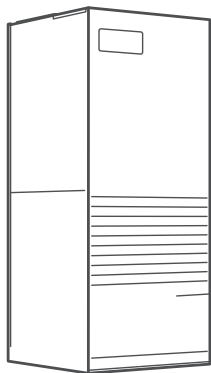

Step 23:

Welcome screen is displayed on Cielo Smart Thermostat!
Follow the on-screen instructions to register your thermostat.



Need Help?

Call: +1 (425) 529-5775 Email: support@cielowigle.com

All Done!
Enjoy your smart home
climate control

Know Your Thermostat



Know Your Thermostat

Mode

Indicates your current thermostat settings (**Heat/Cool/Auto/AUX/Off**)

Humidity

Displays humidity levels in your home

Indoor Temperature

Displays your current home temperature

Weather

Shows current weather plus a 7-day forecast

Menu

Allows you to adjust all system settings, device preferences, and more

Presets

Gives you quick access to Home & Away settings

Set Point

Select your preferred temperature

Hold Settings

Holds your current thermostat settings

QR code to install the Cielo Home app



Troubleshooting

If your Cielo Smart Thermostat doesn't turn on, please try these steps:

1. Close your HVAC panel properly, as some systems may not work if the panel isn't fully closed.
2. Check the backplate wire connections and ensure they are inserted properly into the terminals.
3. In the case of one R-Wire, make sure it is inserted into the R_c terminal.
 - R or R_c or R_H → R_c

In case of more than one R-Wire, make sure R_H is inserted into the R_H terminal and R_c or R is inserted into the R_c terminal.

4. If you installed the C-Wire Adapter, ensure all wires are connected to the correct terminals on your thermostat.
 - R or R_c → R_c
 - G → C
 - Y/Y1 → CWA

Need Help?

Call: +1 (425) 529-5775

Email: support@cielowigle.com

LIMITED WARRANTY & END USER LICENSE AGREEMENT

1. WHAT IS COVERED?

Cielo WiGle, Inc. ("Cielo"), warrants to the owner of the Cielo product contained in this box (the "Product") that the Product will be free from defects in materials and workmanship for a period of three years from the date of delivery following the original retail purchase (the "Warranty Period"). If the Product fails to conform to this Limited Warranty during the Warranty Period, Cielo will, at its sole discretion, either (a) repair or replace the defective Product or component; or (b) accept the return of the Product and refund the money actually paid by the original purchaser for the Product. Repair or replacement may be made with a new or refurbished product or components, at Cielo's sole discretion. If the Product or a component incorporated within it is no longer available, Cielo may, at Cielo's sole discretion, replace the Product with a similar product having similar functions. This is your sole and exclusive remedy for breach of this Limited Warranty. Any Product that has either been repaired or replaced under this Limited Warranty will be covered by the terms of this Limited Warranty for the longer of (a) ninety (90) days from the date of delivery of the repaired Product or replacement Product, or (b) the remaining Warranty Period. This Limited Warranty is transferable from the original purchaser to subsequent owners, but the Warranty Period will not be extended in duration or expanded in coverage for any such transfer.

2. RETURN POLICY

If you are the original purchaser of the Product and you are not satisfied with this Product, you may return it in its original condition within thirty (30) days of the original purchase and receive a full refund.

3. WARRANTY CONDITIONS

Before making a claim under this Limited Warranty, the owner of the Product must (a) visit cielowigle.com/support during the Warranty Period to provide notice of your warranty claim and describe the alleged failure, and (b) comply with Cielo's (or its authorized distributor's) return shipping instructions. Cielo will have no warranty obligations with respect to a returned Product if it determines, in its reasonable discretion after examination of the returned Product, that the Product is an Ineligible Product (defined below).

4. WHAT THIS LIMITED WARRANTY DOES NOT COVER

This Limited Warranty does not cover the following (collectively "Ineligible Products"): (i) Products marked as "sample" or "Not for Sale", or sold "AS IS"; (ii) Products that have been subject to: (a) modifications, alterations, tampering, or improper maintenance or repairs, except if performed by Cielo; (b) handling, storage, installation, testing, or use not in accordance with any User's Guide, Placement Guidelines, or other instructions provided by Cielo; (c) abuse or misuse of the Product; (d) breakdowns, fluctuations, or interruptions in electric power or the telecommunications network; or (e) Acts of God, including but not limited to lightning, flood, tornado, earthquake, or hurricane; or (iii) any non- Cielo branded hardware products, even if packaged or sold with Cielo hardware. This Limited Warranty does not cover consumable parts, including batteries, unless damage is due to defects in materials or workmanship of the Product, or software (even if packaged or sold with the product). Cielo recommends that you use only authorized service providers for maintenance or repair. Unauthorized use of the Product or software can impair the Product's performance and may invalidate this Limited Warranty.....

For detailed information on warranty, please visit:
cielowigle.com/legal

For any queries visit:
cielowigle.com

OR

Call: +1 (425) 529-5775
Email: support@cielowigle.com

Cielo WiGle, Inc. Redmond, WA, USA
All rights reserved.